

DH-HAC-HFW1500TH-I8

5MP HDCVI IR Bullet Camera



- Max. 20fps@5MP
- HD and SD output switchable
- 3.6mm fixed lens (6mm, 8mm optional)
- Max. IR length 80m, Smart IR
- IP67, DC12V



System Overview

Experience superior 5MP video and the simplicity of reusing existing coaxial infrastructure with HDCVI. The Lite series 5MP HDCVI camera features a compact design and offers a high quality image with rich details at a friendly price. It offers various vari-focal/fixed lens models with a multi-language OSD and HD/SD switchable output. Its structural flexibility and high cost-performance makes the camera an ideal choice for SMB solutions.

Functions

4 Signals over 1 Coaxial Cable

HDCVI technology supports 4 signals to be transmitted over 1 coaxial cable simultaneously, i.e. video, audio*, data and power. Dual-way data transmission allows the HDCVI camera to interact with the HCVR, such as sending control signal or triggering alarm. Moreover, HDCVI technology supports PoC for construction flexibility.

* Audio input is available for some models of HDCVI cameras.

Long Distance Transmission

HDCVI technology guarantees long-distance and real-time transmission without any loss. It supports up to 700m for 5MP HD video via coaxial cable, and up to 300m via UTP cable.*

*Actual results verified by real-scene testing in Dahua's test laboratory.

Simplicity

HDCVI technology inherits the born feature of simplicity from traditional analog surveillance system, making itself a best choice for investment protection. HDCVI system can seamlessly upgrade the traditional analog system without replacing existing coaxial cabling. The plug and play approach enables full HD video surveillance without the hassle of configuring a network.

Smart IR

The camera is designed with microcrystalline LED IR illumination for best lowlight performance. Smart IR is a technology to ensure brightness uniformity in B/W image under low illumination. Dahua's unique Smart IR adjusts to the intensity of camera's infrared LEDs to compensate for the distance of an object, and prevents IR LEDs from overexposing images as the object come closer to the camera.

HD/SD Switchable

The camera supports switchable HDCVI high definition video output and CVBS standard definition video output. The two formats can be switched over through OSD menu or by PFM820 (UTC controller). This feature makes the camera to be compatible with both HCVRs and existing analog DVRs and also facilitates debugging through analog testers.

Multi-language OSD

OSD menu provides multiple image adjustments and function settings to meet the requirements of different monitoring scenes. The OSD menu includes configurations such as backlight mode, day/night, white balance, privacy mask and motion detect. The camera supports 11 languages for OSD menu, namely, Chinese, English, French, German, Spanish, Portuguese, Italian, Japanese, Korean, Russian and Polish.

Protection

The camera's outstanding reliability is unsurpassed due to its rugged design. The camera is protected against water and dust with IP67 ranking, making it suitable for indoor or outdoor environments. With working temperature range of -40 °C to +60 °C (-40 °F to +140 °F), the camera is designed for extreme temperature environments. Supporting ±30% input voltage tolerance, this camera suits even the most unstable power supply conditions. Its 4KV lightning rating provides protection against the camera and its structure from the effects of lightning.

Technical Specification

Camera

Image Sensor	1/2.7 inch CMOS
Effective Pixels	2592 (H) × 1944 (V), 5MP
Electronic Shutter Speed	PAL:1/25s–1/100000s NTSC:1/30s–1/100000s
Minimum Illumination	0.02Lux/F2.0, 30IRE, 0Lux IR on
IR Distance	Distance up to 80 m (262.46 ft)
IR On/Off Control	Auto; manual
IR LEDs Number	2
Pan/Tilt/Rotation Range	Pan: 0°–360° Tilt: 0°–180° Rotation: 0°–360°

Lens

Lens Type	Fixed-focal				
Mount Type	M12				
Focal Length	3.6 mm; 6 mm; 8 mm				
Max. Aperture	F2.0				
Angle of View	3.6 mm: 101° × 77.5° × 56.5° (diagonal × horizontal × vertical) 6 mm: 61° × 49° × 37° (diagonal × horizontal × vertical) 8 mm: 47° × 37° × 28° (diagonal × horizontal × vertical)				
Iris Type	Fixed iris				
Min Photographic Distance	1.4 m/2.8 m/4.5 m (4.59 ft/9.18 ft/14.76 ft)				
DORI Distance	Lens	Detect	Observe	Recognize	Identify
	3.6 mm	80.0 m (262.46 ft)	32.0 m (68.89 ft)	16.0 m (52.49 ft)	8.0 m (26.24 ft)
	6 mm	120.0 m (393.70 ft)	48.0 m (104.98 ft)	24.0 m (78.74 ft)	12.0 m (39.37 ft)
	8 mm	160.0 m (590.55 ft)	64.0 m (209.97 ft)	32.0 m (68.89 ft)	16.0 m (52.49 ft)

Video

Video Frame Rate	CVI: 5M@20fps; 4M@25fps/30fps; 1080P@25fps/30fps; AHD: 5M@20fps; 4M@25fps/30fps; 1080P@25fps/30fps; TVI: 5M@20fps; 4M@25fps/30fps; 1080P@25fps/30fps; CVBS: 960H
Resolution	5MP (2592 × 1944); 4MP (2560 × 1440); 1080P (1920 × 1080); 960H (960 × 576/960 × 480)
Day/Night	Auto switch by ICR
BLC	BLC/HLC/DWDR
WDR	DWDR
White Balance	Auto; manual
Gain Control	Auto; manual
Noise Reduction	2D NR

Smart IR	Yes
Electronic Defog	Yes
Mirror	Off/On
Privacy Masking	Off/On (8 area, rectangle)

Certifications

Certifications	CE (EN55032, EN55024, EN50130-4) FCC (CFR 47 FCC Part 15 subpartB, ANSI C63.4-2014) UL (UL60950-1+CAN/CSA C22.2 No.60950-1)
----------------	---

Port

Video Port	Video output choices of CVI/TVI/AHD/CVBS by one BNC port
------------	--

Power

Power Supply	12V±30% DC
Power Consumption	Max 5.1W (12V DC, IR on)

Environment

Operating Temperature	-40°C to +60°C (-40°F to +140°F); <95% (non-condensation)
Storage Temperature	-40°C to +60°C (-40°F to +140°F); <95% (non-condensation)
Protection Grade	IP67

Structure

Casing	Metal front face + plastic main body + metal bracket
Dimensions	240.7 mm × 90.7 mm × 90.4 mm (9.48" × 3.57" × 3.56")
Net Weight	410 g (0.90 lb)
Gross Weight	616 g (1.36 lb)

Ordering Information

Type	Part Number	Description
5MP Camera	DH-HAC-HFW1500THP-I8 3.6mm	5MP HDCVI IR Bullet Camera, PAL
	DH-HAC-HFW1500THP-I8 6mm	
	DH-HAC-HFW1500THP-I8 8mm	
	DH-HAC-HFW1500THN-I8 3.6mm	5MP HDCVI IR Bullet Camera, NTSC
	DH-HAC-HFW1500THN-I8 6mm	
	DH-HAC-HFW1500THN-I8 8mm	
Accessories	PFA130-E	Water-proof junction box (ceiling mount)
	PFA130-E + PFA152-E	Water-proof wall mount bracket + pole mount bracket (pole mount)
	PFA130-E + PFA151	Water-proof wall mount bracket+corner bracket (corner mount)
	PFA12A	Plastic junction box
	DH-PFM320D-015	12V 1.5A DC power adapter
	DH-PFM321-EN	12V 1A DC power adapter (for european countries)
	DH-PFM321-BS	12V 1A DC power adapter (for UK)
	DH-PFM321-US	12V 1A DC power adapter (for US)
	PFM820	UTC controller
	DH-PFM906	Integrated mount tester
	DH-PFM800-4K	Passive video balun



DH-PFM906
Integrated mount tester



DH-PFM800-4K
Passive video balun

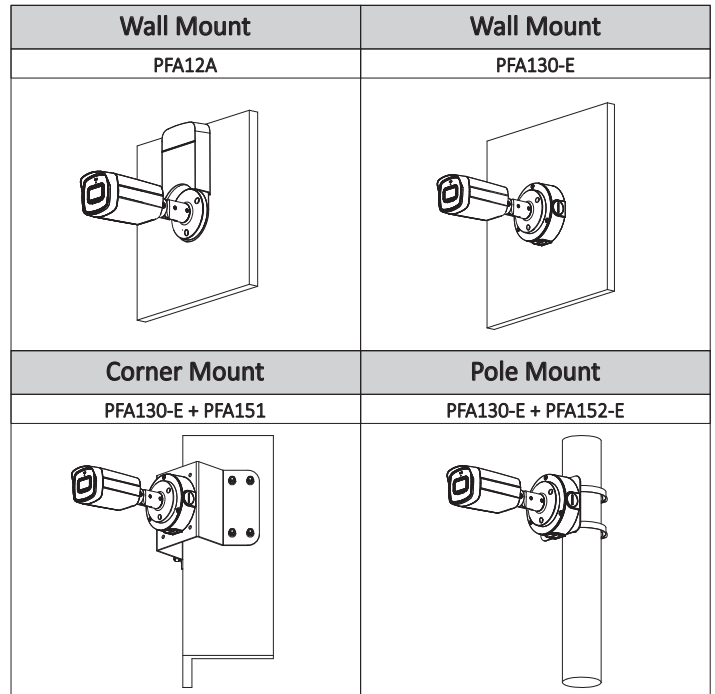

Accessories

Optional:



PFA130-E
Water-proof junction box (ceiling mount)



PFA130-E + PFA152-E
Water-proof wall mount bracket + pole mount bracket (pole mount)



PFA130-E + PFA151
Water-proof wall mount bracket+corner bracket (corner mount)



PFA12A
Plastic junction box



DH-PFM320D-015
12V 1.5A DC power adapter



DH-PFM321-EN
12V 1A DC power adapter (for european countries)



DH-PFM321-BS
12V 1A DC power adapter (for UK)



DH-PFM321-US
12V 1A DC power adapter (for US)



PFM820
UTC controller

Dimensions (mm[inch])

